

BUTTERFLY VALVE



- Product** : Butterfly Valve
- Application** : Shut-off valve, by turning the valve disc
- Type** : Manual by turning 3-position pull handle or 12-position gripper handle
Pneumatic with air actuator
- Optional** : Control & Indication Unit to be mounted on actuator
- Body Material** : Stainless Steel 304 & 316L made out from precision CNC milling machine
: Body can changeable, low torque.SMS, DIN, 3A Weld End and Clamp End.
- Rubber Material** : EPDM, Silicone
- Working Pressure** : Maximum 10 bar
- Working Temperature** : -10 degree C to 135 degree C with EPDM seal
: -10 degree C to 170 degree C with Silicone seal
: -10 degree C to 200 degree C with Viton seal
: -10 degree C to 250 degree C with Teflon seal
- Air Pressure for Air Actuator** : 5 - 7 bar
- Size** : 1" - 12", DN 10 - DN200





BUTTERFLY VALVE (INCH STANDARD)

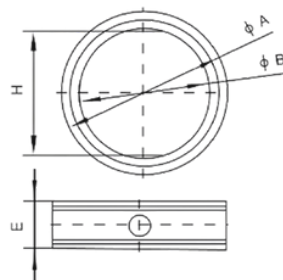
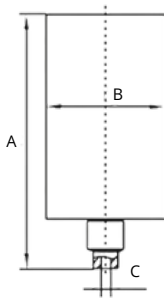
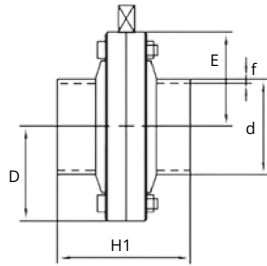

Butterfly Valve (Weld End)

SIZE	E	D	H1	d	f
1"	34.6	39.5	47	25.4	1.5
1.5"	34.6	39.5	47	38.1	1.5
2"	46.2	50	52	50.8	1.5
2.5"	53.6	57	54	63.5	2
3"	61.3	65	56	76.2	2
4"	78.1	81	68	101.6	2

Butterfly Valve Actuator

SIZE	A	B	C
1"	184	85	10
1.5"	184	85	10
2"	184	85	10
2.5"	184	85	10
3"	184	85	12
4"	226	109	12

Butterfly Valve Seal (Epdm, Silicone)

SIZE	A	B	H	E
1"	36.7	22.8	18	22.2
1.5"	49.8	35.3	32	22.2
2"	65	48	45	22.2
2.5"	77.8	59.7	57	23
3"	94	85	69	27.2
4"	126.2	109	95	35.4





BUTTERFLY VALVE (DIN STANDARD)

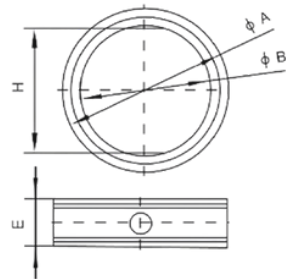
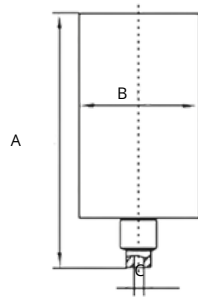
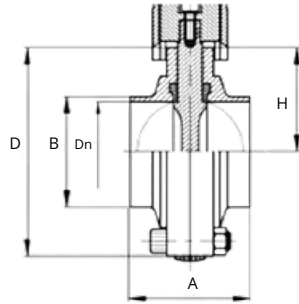

Butterfly Valve (Weld End) (DIN)

SIZE	D	B	A	H	Dn
10	78	13	50	39	10
15	78	19	50	39	15/16
20	78	23	50	39	19/20
25	78	29	50	39	25/26
32	86	35	50	43	31/32
40	83	41	46.85	40	37
50	106	53	52	53	49/50
65	124	70	56	62	66
80	139	85	60	69.5	81
100	159	104	64	79.5	100
125	185	129	80	92.5	125
150	214	154	90	107	150
200	285	204	92	142.5	200
250	340	254	100	170	250
300	394	304.8	120	197	298

Butterfly Valve Actuator (DIN)

SIZE	A	B	C
25	184	85	10
32/40	184	85	10
50	184	85	10
65	184	85	10
80	184	85	12
100	226	109	12
125	224.5	109	14.1
150	303	133	14.1

Butterfly Valve Seal (Epdm, Silicone) (DIN)

SIZE	A	B	H	E
25	36.7	22.8	18	22.2
32	49.8	35.3	32	22.2
40	65	48	45	22.2
50	77.8	59.7	57	23
65	94	85	69	27.2
80	126.2	109	95	35.4
40	65	48	45	22.2
50	77.8	59.7	57	23
65	94	85	69	27.2





HYGIENIC BUTTERFLY VALVE

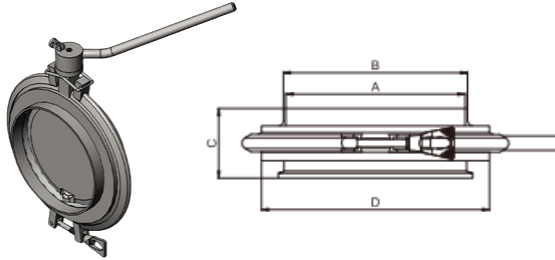

HYGIENIC BUTTERFLY VALVE

SIZE	A	B	C	D
100	100	104	56	155
150	150	154	70	230
200	200	206	75	280
250	247	254	80	327
300	298	304.8	90	380

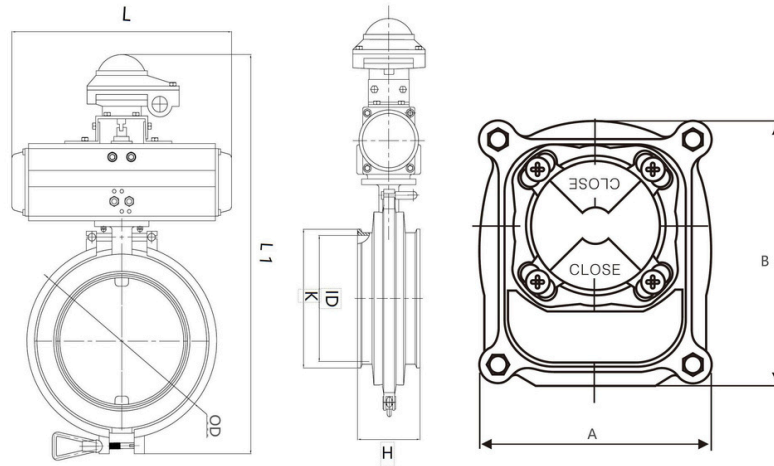

HYGIENIC BUTTERFLY VALVE

SIZE	ID	K	H	OD	L	L1	A	B
150	150	183	90	242	248	530	85	110
200	200	233.5	100	293	277	600	85	110

